

Light collection and injection add-on for (S)TEMs

Cathodoluminescence - Photoluminescence - Gain spectroscopy - Local thermal excitation

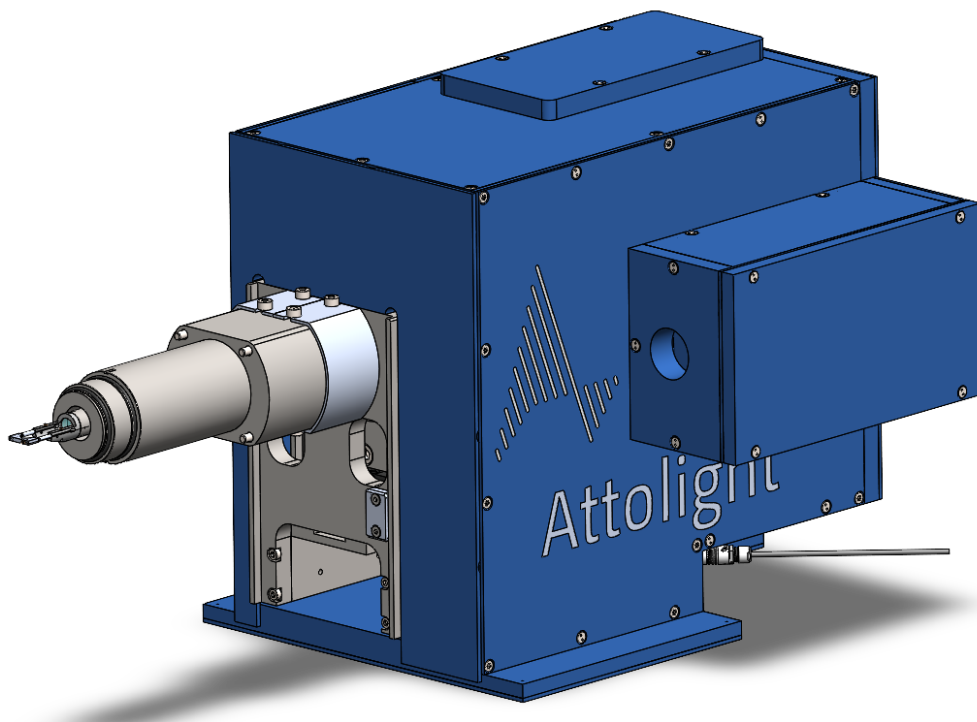

Benefit from a versatile system that includes both light collection and injection modes.

Reveal unprecedented features of your sample: composition, structure and defects.

Take advantage from a fully optimized system with large collection angle.

Excite samples to reveal local behaviour under light/thermal excitation.

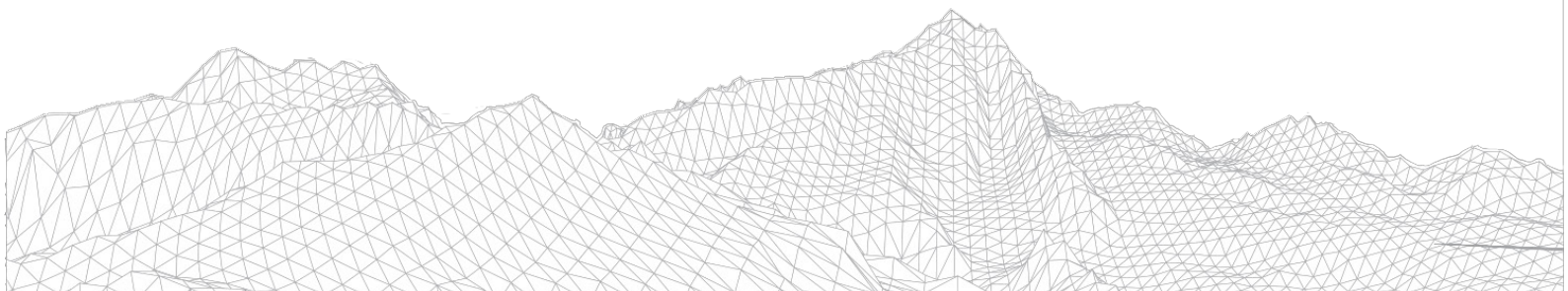

The Mönch is an easy to use and accurate add-on for light collection or injection in (S)TEM thanks to:

- A **mirror independent from the sample holder** allowing for a perfect and optimized alignment ;
- An absolute encoding system ensuring **high alignment precision and reproducibility** (100nm-precision) ;
- The ability to **inject and/or collect light** either in **free space or via an optical fiber**.

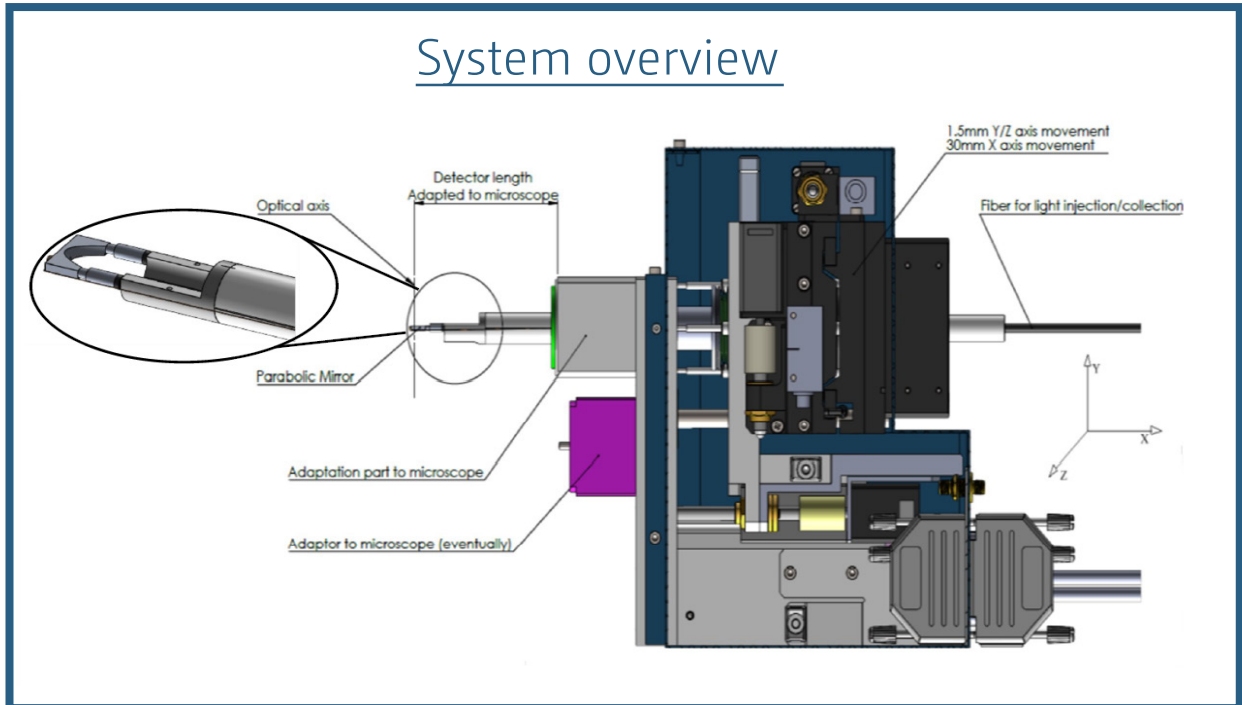

Light collection mode:

The Mönch has been designed and carefully optimized to achieve unprecedented signal-to-noise ratio thanks to:

- A **proprietary parabolic collection mirror** designed to fit into pole piece gap as small as 5mm;
- A **positioning system** with sub-micrometer precision for perfect alignment of the mirror with respect to the sample;
- A **high curvature parabolic mirror** with a $NA > 0.4$;
- A **working distance reduced to 300 μ m** to maximize the light collection/injection efficiency;
- A **patented asymmetric optical fiber** designed to preserve brightness and spectral resolution.

Light injection mode:

The Mönch reaches unprecedented level of performances and versatility thanks to:

- A **beam size reduced to few microns** for localized light or thermal excitation of samples;
- The ability to perform **injection and light collection measurements simultaneously**.

Patented optical fiber:

The Mönch uses of an asymmetric optical fiber with a bundle rearrangement from round to parallel to the entrance slit of the imaging spectrograph. This enables keeping constant spectral resolution even when the slit is opened and the spot moving at the entrance of the slit due to scanning.

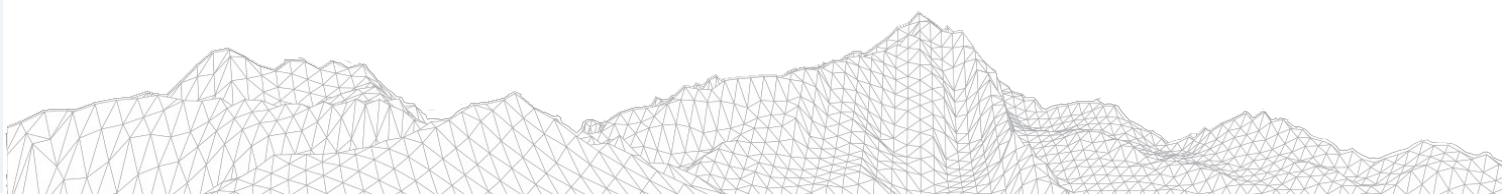
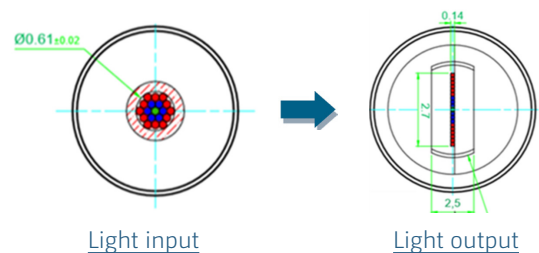

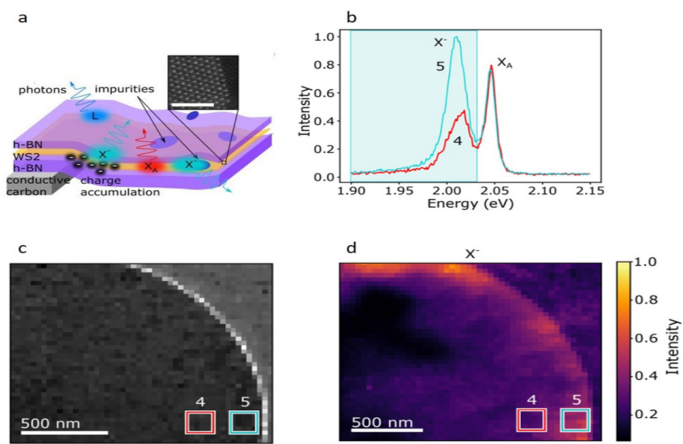

a) h-BN/WS₂/h-BN heterostructure shows three emission lines: excitons (X_A), trions (X⁻) and localized emitters (L). b) CL spectra for the regions highlighted in c and d. c) HAADF region measured in d and d) the X⁻ intensity map revealing local trion enhancement. (Bonnet et al., arXiv:2102.06140 (2021)).

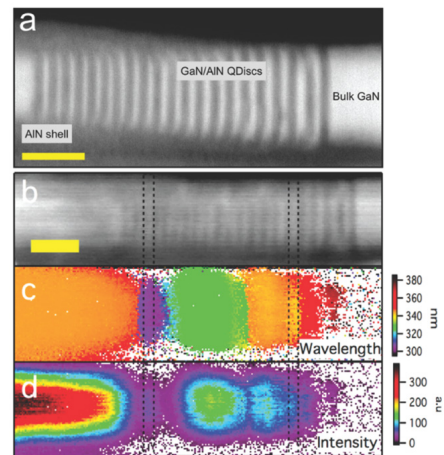

Spectral imaging of a GaN/AlN NW with 20 QDisks (a) HAADF image of a GaN/AlN nanowire Scale bar is 20 nm. (b) HAADF of the NW, acquired simultaneously with the CL. (c) Wavelength position of the most intense peak. (d) Intensity of the most intense peak. (L.Zagonel et al., Nano letters, 11(2), 568-573 (2011))

Light collection/injection modes

Mode	Excitation source	Analysis (detection)
Light collection Sample under vacuum → Outside	E-beam, Laser, Thermal, Electrical...	Cathodoluminescence (light)
Light injection Outside → Sample under vacuum	Laser ...	Electron imaging (electron) in photoemission/thermoionic regimes
Light injection + collection Outside ↔ Sample under vacuum	Laser...	Photoluminescence (light)

Topics:

- Electronics & Optoelectronics (GaN, InP, SiC...)
- Photovoltaic cells (GaAs, CdTe, Perovskites...)
- Light emitting diodes (LEDs)
- 2D materials (Graphene, BN, WS₂, diamond...)
- Noble metals (plasmonic)
- Photonic crystals
- Quantum wells & quantum dots
- Minerals, glasses, ceramics and gemstones)
- Inorganic coatings
- Organic, polymer samples

Mönch: Unique Light collection/injection add-on for STEM

- High spectral resolution
- High collection efficiency
- Fits into small pole-piece gap
- Versatile and flexible system
- Mirror independent from the sample
- Sub-micrometer alignment of mirror
- No need for sample pre-alignment
- CL analysis of whole sample area
- High field of view
- No vignetting
- Large choice of detectors
- Fast hyperspectral map measurement time
- Unprecedented signal-to-noise ratio
- No compromise between brightness and spectral resolution
- Compatible with other techniques (EELS, EDS...)

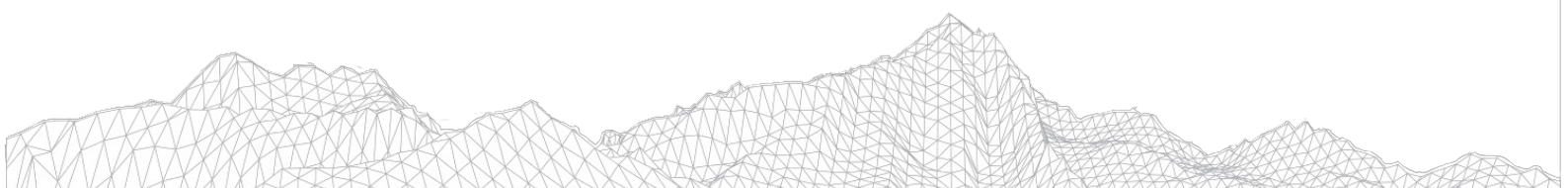

Mönch Features

Specifications

Mirror:

- High numerical aperture parabolic mirror (NA>0.4)
- Mirror reflection : up to 90% from 200nm to 1.7µm
- Compatibility for light collection and injection modes
- Optimized sample to mirror distance : 300µm

Micro-positioning system:

- Travel range: 30mm (X), +/-1.5mm (Y), +/-1.5mm (Z)
- Automated retractable mirror
- Absolute encoders with 100nm-precision
- Stage touch alarm
- Compact module : 161mm x 210mm x 133mm
- Compatible with Thorlabs cage system

System control:

- External scanning card with 4 inputs (12 bits) for additional single channel detectors (PMT...); 2 outputs for controlling the STEM scan (X and Y); 1 output for the beam blanker.
- Fastest measurement speed: 900Hz (18s for a 128x128 map)

Software:

- Arm/mirror control software (Windows® 10 or higher, 64 bits)
- Acquisition/visualisation module for Gatan Digital Micrograph

Light collection/injection couplings:

- Optical fiber with adapted insertion slot
- Free space to avoid loss of spatial coherence and degradation of signal power density
- *Switching between both modes takes few seconds*

Dispersive spectrometer

- Dual inputs and output
- 328 mm focal length
- Up to 4 turrets with large choice of gratings

Detectors

- High speed UV-Visible CCD camera (200 nm–1100 nm)
- InGaAs near infra-red camera (900 nm–1700 nm)
- Panchromatic detection (PMT; 200 nm–900 nm)
- *Others detectors on request*

Light injection : Beam size simulation

The specific mirror shape enables generating a micrometer beam spot size on the sample surface. For a input laser beam diameter of 0.5mm, the beam spot size on the sample surface is approx. 2.0µm-diam.

Optical simulation:

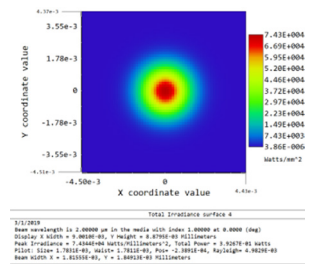

STEM compatibility:

- Compatible with most of the (S)TEM models : TFS, JEOL, Nion, VG...
- Pole-piece gap : minimum 5.0mm
- One available port in the PPG plane
- Contact us at : contact@attolight.com to check the compatibility of your (S)TEM models

About Attolight AG:

Attolight AG started off to revolutionise cathodoluminescence (CL) by designing top of the line CL instruments that deliver superior performance, maximum ease-of-use and make quantitative cathodoluminescence. The Company firmly believes in the potential of cathodoluminescence and aims at establishing the technology as a standard in-line inspection method in semiconductor industry.

Attolight AG is a company with global presence with systems in Europe, Asia, and North America. The Company headquartered is located in Ecublens close to Lausanne-Switzerland.

